







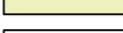

# PUZ - LOTIZARE LOCUINTE INDIVIDUALE SI MICSORARE ZONA PROTECTIE SANITARA STATIE DE EPURARE - REGLEMENTARI URBANISTICE -

LEGENDA:

-  LIMITA ZONA STUDIATA
-  LIMITA ZONA REGLEMENTATA PUZ
-  DRUMURI EXISTENTE SI PROPUSE
-  TROTUARE EXISTENTE SI PROPUSE
-  CLADIRI PROPUSE P+E
-  ZONA LOCUINTE INDIVIDUALE
-  ZONA VERDE ZONA CANALIZARE EXISTENTA
-  ZONA PROTECTIE REEA CANALIZARE + CONDUCTA CANALIZARE
-  LIMITA ZONA PROTECTIE SANITARA  
STATIE DE EPURARE  
200M CONFORM STUDIULUI
-  IMPREJMUIRE OPAACA DUBLATA DE GARD VIU INALT 2.00M

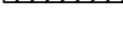

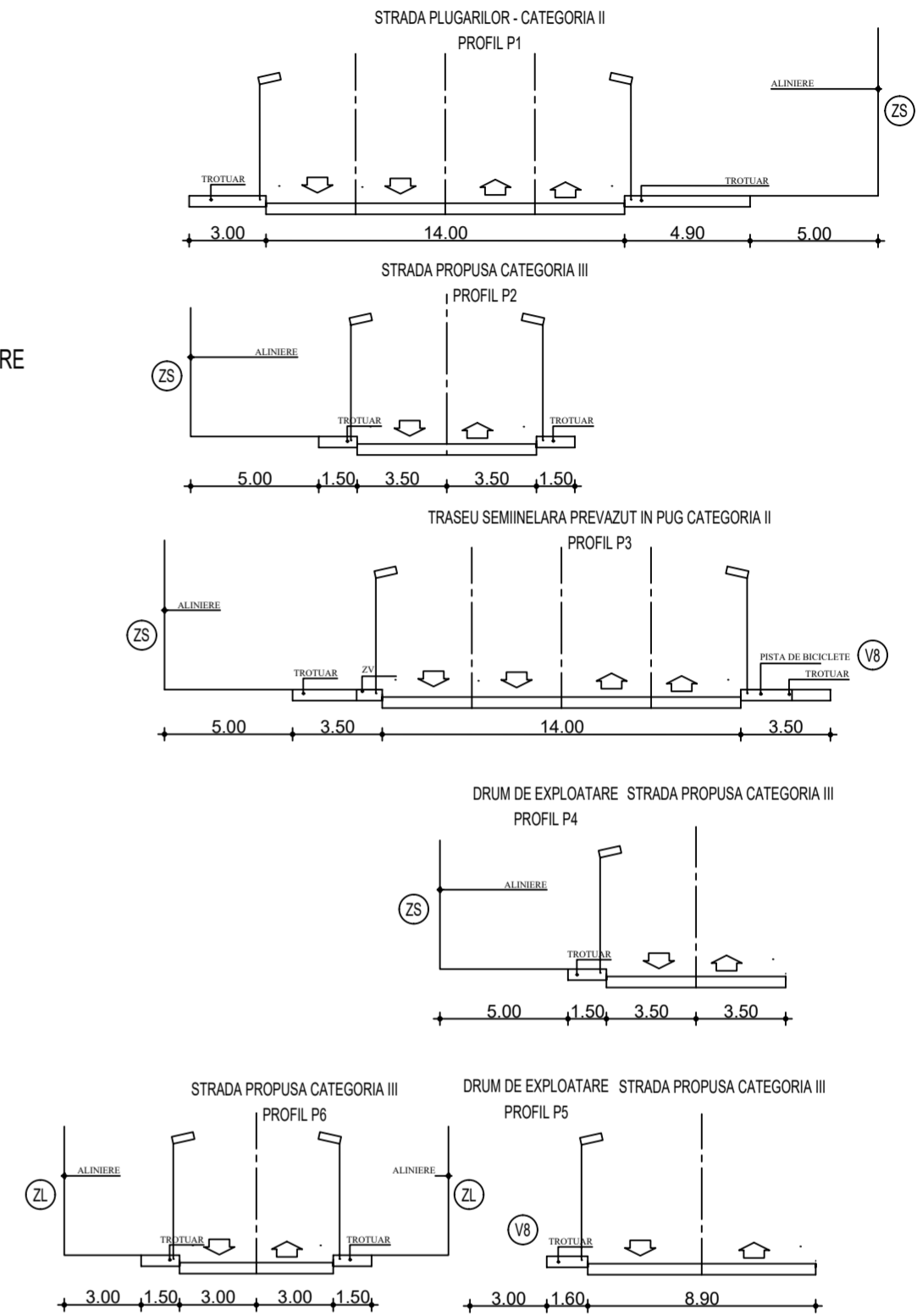

**PUZ - ZONA PRESTARI SERVICII COMERT,  
MICA INDUSTRIE DEPOZITARE, IN CURS DE AVIZARE  
CONFORM CU NR.3435/23.12.2022**

## BILANT TERITORIAL

NR.CRT.	ZONE FUNCTIONALE	EXISTENT mp	EXISTENT %	PROPUSE mp	PROPUSE %
1.	ZONA TEREN ARABIL	11 487	100.00	0	0
2.	ZONA LOCUINTE INDIVIDUALE	0	0.00	6 834	59.49
3.	CIRCULATII	0	0.00	4 165	36.26
4.	ZONA CONDUCTA CANALIZARE SI DE PROTECTIE	0	0.00	336	2.93
5.	ZONA VERDE REZERVA TRASEE RELETE EDILITARE	0	0.00	152	1.32
6.	TOTAL ZONA STUDIATA	11 487	100.00	11 487	100.00

POT MAX.=35%  
CUT MAX.=0.80  
REGIM DE INALTIME MAX=S+P+E+M/R  
ZONA VERDE MINIM IN INCINTA 30%

 <b>BIROU DE ARHITECTURA</b> J 08/206/1996, C.F. R10290793, BRASOV str. CALEA BUCURESTI 51 ap. 2 TEL 0268/306332 FAX 0268/306333 e-mail topform@arhtelecom.net		 Beneficiar: RUJIA DORIN, RUJIA DANIEL, CONSTANTIN LIVIA-MARIA Amplasament: str. PLUGARILOR, NR.2, mun. Brasov, jud. BRASOV	Proiect nr. 92/2022 Faza: PUZ Plansa nr. U-04	
SPECIFICATIE	NUME	SEMNTATURA	Scara:	Titlu proiect: PUZ - LOTIZARE LOCUINTE INDIVIDUALE SI MICSORARE ZONA PROTECTIE SANITARA STATIE DE EPURARE Titlu plansa: ILUSTRARE MOBILARE URBANISTICA
SEF PROIECT	arh. Atzberger M.		1:1000	
PROIECTAT	arh. Atzberger M.		Data:	
DESENAT	arh. Atzberger M.		10.2023	