







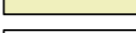

PUZ - LOTIZARE LOCUINTE INDIVIDUALE SI MICSORARE ZONA PROTECTIE SANITARA STATIE DE EPURARE - REGLEMENTARI URBANISTICE -

LEGENDA:

-  LIMITA ZONA STUDIATA
-  LIMITA ZONA REGLEMENTATA PUZ
-  DRUMURI EXISTENTE SI PROPUSE
-  TROTUARE EXISTENTE SI PROPUSE
-  CLADIRI PROPUSE P+E
-  ZONA LOCUINTE INDIVIDUALE
-  ZONA VERDE ZONA CANALIZARE EXISTENTA
-  ZONA PROTECTIE REEA CANALIZARE + CONDUCTA CANALIZARE
-  LIMITA ZONA PROTECTIE SANITARA
STATIE DE EPURARE
200M CONFORM STUDIULUI
-  IMPREJUMIURE OPAKA DUBLATA DE GARD VIU INALT 2.00M

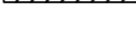

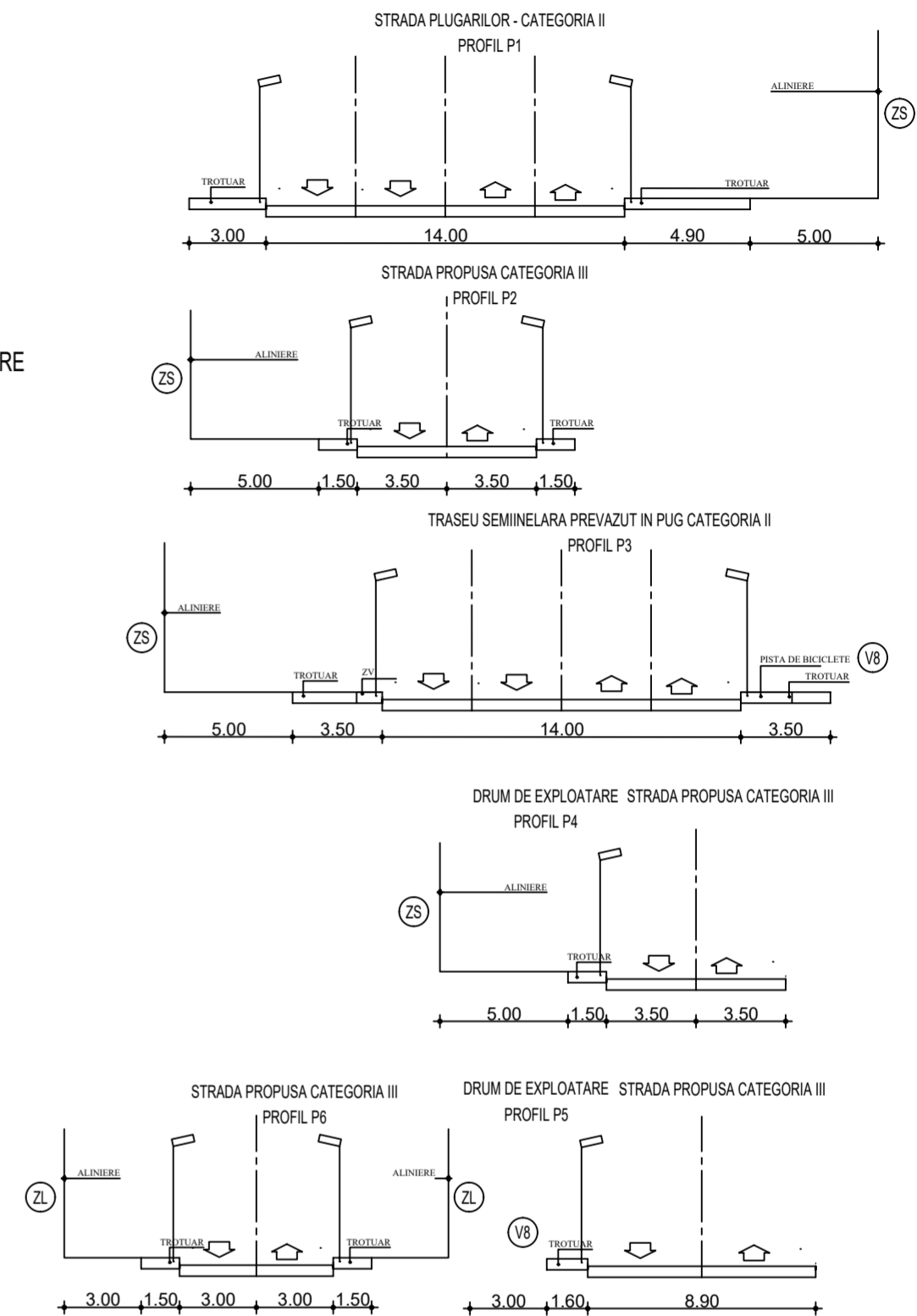

**PUZ - ZONA PRESTARI SERVICII, COMERT,
MICA INDUSTRIE DEPOZITARE, IN CURS DE AVIZARE
CONFORM CU NR.3435/23.12.2022**

BILANT TERITORIAL

NR.CRT.	ZONE FUNCTIONALE	EXISTENT mp	EXISTENT %	PROPUSE mp	PROPUSE %
1.	ZONA TEREN ARABIL	11 487	100.00	0	0
2.	ZONA LOCUINTE INDIVIDUALE	0	0.00	6 834	59.49
3.	CIRCULATII	0	0.00	4 165	36.26
4.	ZONA CONDUCTA CANALIZARE SI DE PROTECTIE	0	0.00	336	2.93
5.	ZONA VERDE REZERVA TRASEE RELETE EDILITARE	0	0.00	152	1.32
6.	TOTAL ZONA STUDIATA	11 487	100.00	11 487	100.00

POT MAX.=35%
CUT MAX.=0.80
REGIM DE INALTIME MAX=S+P+E+M/R
ZONA VERDE MINIM IN INCINTA 30%

		BIROU DE ARHITECTURA J 08/206/1996, C.F. R10290793, BRASOV str. CALEA BUCURESTI 51 ap. 2 TEL 0268/306332 FAX 0268/306333 e-mail topform@arhtelecom.net				Beneficiar: RUJJA DORIN, RUJJA DANIEL, CONSTANTIN LIVIA-MARIA	Proiect nr. 92/2022
SPECIFICATIE	NUME	SEMNATURA	Scara:	Titlu proiect:		Faza:	
PROIECTAT	arh. Atzberger M.		1:1000	PUZ - LOTIZARE LOCUINTE INDIVIDUALE SI MICSORARE ZONA PROTECTIE SANITARA STATIE DE EPURARE		PUZ	
DESENAT	arh. Atzberger M.		Data:	Titlu planşa:		Planşa nr.	
			10.2023	REGLEMENTARI URBANISTICE		U-03	